

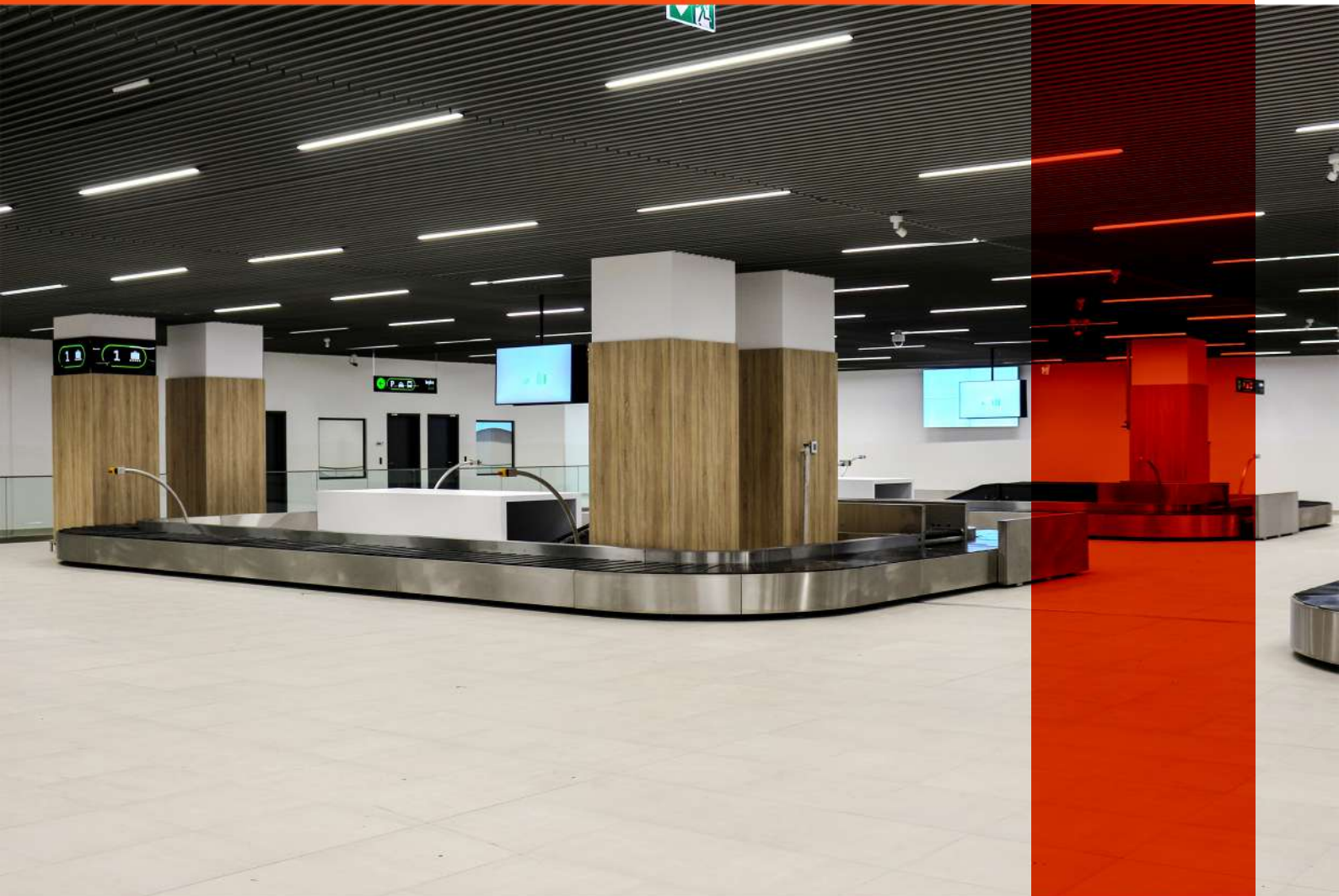

CITCONveyors
Automated Conveyor Systems

COMPLETE SOLUTIONS FOR AIRPORTS



Quality is carrying your business.

1999

Year
Established

10.000+

Delivered
Conveyors

50+

Kilometers of
Total length

2000+

Clients

www.airportconveyors.eu

OUR PROJECTS IN THE AIRPORT INDUSTRY

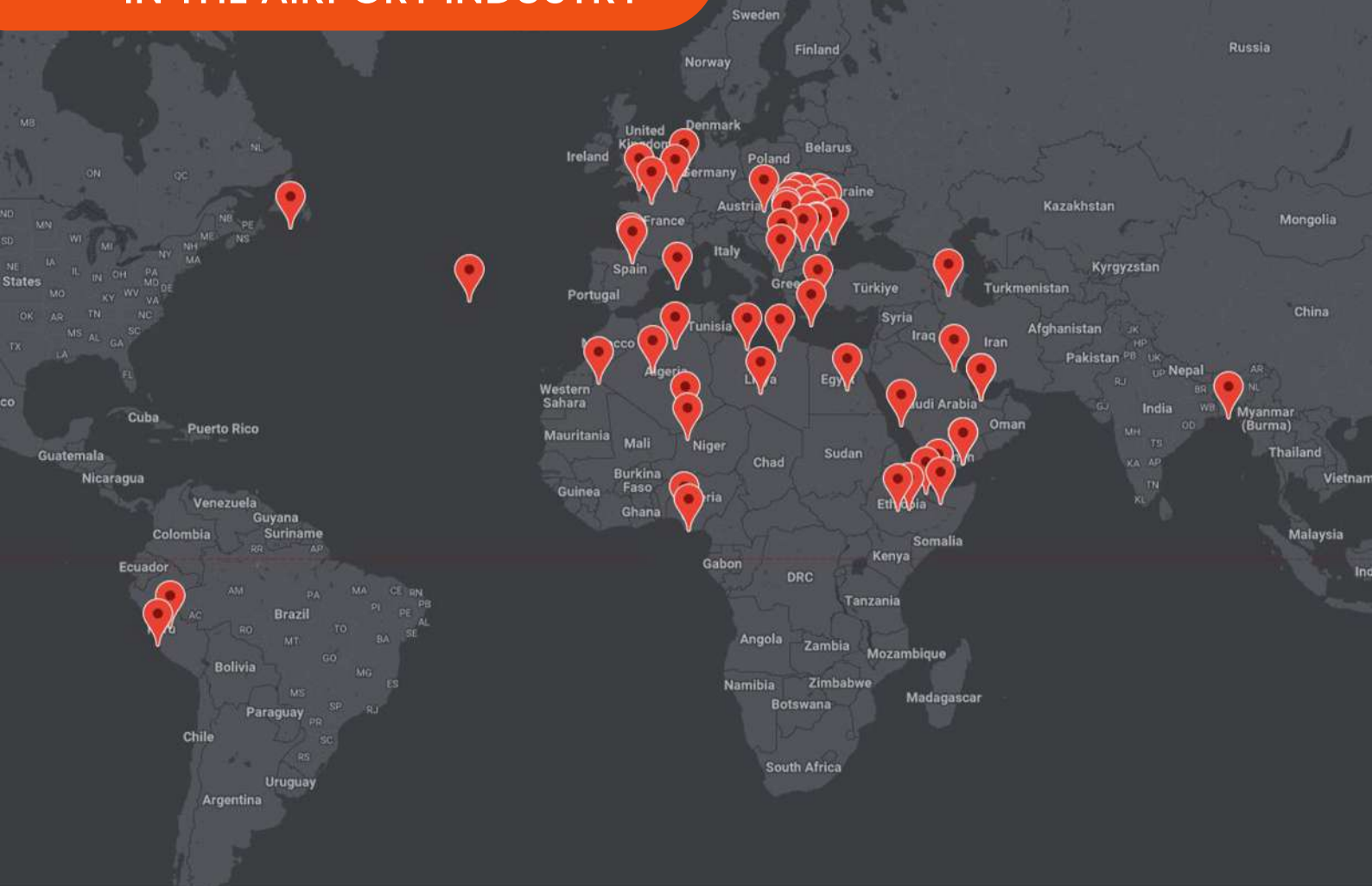

As an established **Airport Conveyor Manufacturer**, we have successfully implemented projects across **Europe, Africa, America, the Middle East, and Asia**. Our extensive experience also includes serving as a supplier for projects in various other regions worldwide.

Starting from the design up to the actual implementation of the project, service and post-service phase we guarantee our clients a high level of transparency. We believe that this is the key to having successful projects and satisfied partners and, furthermore, we believe in the H2H approach of the sale, where the attention to the people involved is as important as the project itself.



ABOUT US



As an airport conveyor manufacturer with 25 years of experience, CITConveyors is known for implementing multiple projects around the world. Quality and promptness are the defining goals of this company which are reflected in its customers' successes.

CITConveyors, division of **Self Trust Romania**, The Romanian Conveyor Factory, addresses the International market.

Among the company values are competitiveness, flexibility, reliability and client-orientation because every effort is made to provide the best solution that fits the client.



OUR PRODUCTS

Our range of products ensures that no matter the type of project, **CITConveyors** as an Airport Conveyor Manufacturer can deliver the full package:

- **Check-in Desks;**
- **Check-in Conveyors:** with certified loading cells and displays (CE, OIML, EAC);
- **Collecting and metering Conveyors;**
- **Baggage Carousels** (Horizontal, Inclined, Make-up);
- **Baggage Handling Systems;**
- **Diverter** (horizontal and vertical);
- **Return Tray System** (Automatic, Manual);
- **Baggage Runway Conveyors;**
- **Roller Conveyors;**
- **Merge Units;**
- **Curved Belt Conveyors;**
- **Spiral Chutes;**
- **Self Check-in Kiosks;**
- **Baggage Drop Systems** (SBD);
- **Passport Control Cabins.**

READY FOR CHALLENGES



CHECK-IN DESKS



CHECK-IN DESKS

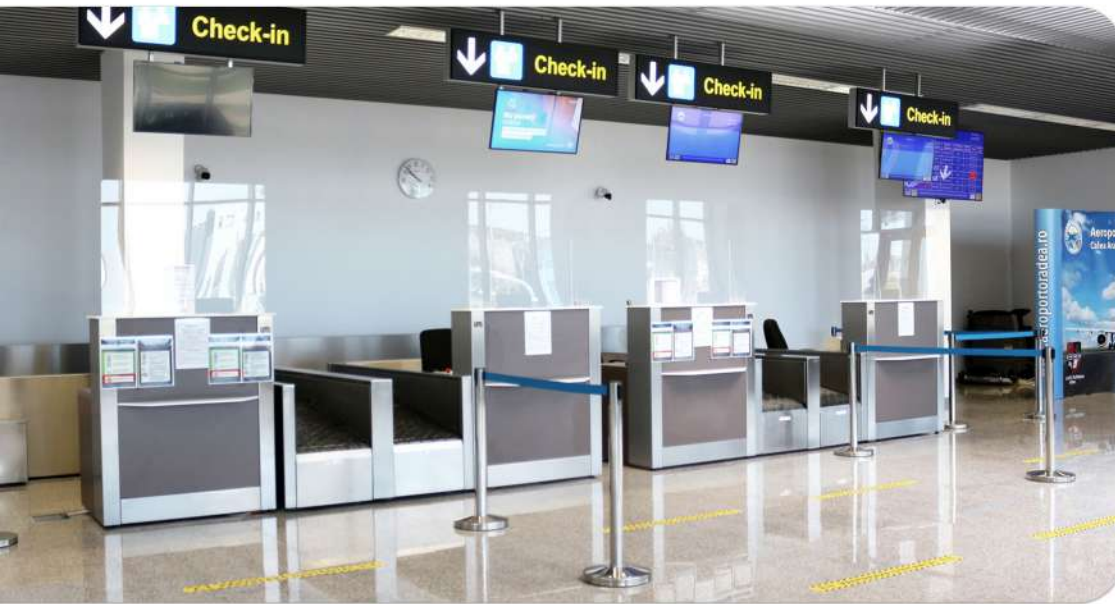

- Single units;
- Double units;
- Integrated Weigh-in Conveyor Control console (with Buttons: start, stop, forward, Emergency Stop);
- Integrated Passenger Display;
- Integrated Operator Display;
- Ergonomic layout for Passenger and Operator;
- Passenger-side small Shelf (for small bags, documents, etc.);
- Independent small cabinet for computer and/or other auxiliary equipments;
- Lockable cabinet for sensitive equipment or documents.

Materials: Wood, Compact laminated panels, Composite materials (Eq Corian: solid surface material composed of acrylic polymers and fragmented natural stone), Stainless steel, Secure Glass, Plastic, Natural stone (marble, granite, travertine).



Wide variety of design available

Dedicated areas for equipment (label printers, monitors, computers, documents)

Ergonomic design for Passengers and Operators



CITCONveyors
Automated Conveyor Systems

division of

SELF TRUST
The Romanian Conveyor Factory

Airport industry

Head office and factory

34th Bucium Street,
Iasi, Romania
+40 232 276 596
office@selftrust.ro

Sales office

96th Popa Stoica Farcas,
Bucharest, Romania
+40 213 32 405
office2@selftrust.ro

www.airportconveyors.eu

www.selftrust.ro
www.citconveyors.com



CHECK-IN CONVEYORS



CHECK-IN CONVEYORS



CITCONveyors
Automated Conveyor Systems

division of

SELF TRUST
The Romanian Conveyor Factory



- Single units;
- Double units (side by side);
- Adjustable configuration: Weigh-in + (tag) + induction system;
- Modular construction;
- Single-stage, double stage, triple stage available in both single or double units (side by side);
- The control console can be integrated in the side of the conveyor or the Check-In Desk (Counter);
- Low input height (310 mm);
- Width from 500 mm up to 1.000 mm;
- Fitted with sensors to control the positioning of the baggage on each conveyor;
- Easy maintenance.

Airport industry



Quality components

Low gap between
conveyors
eliminating the risk for the
baggage to get stuck in transition

Easy access for
maintenance
procedures

Head office and factory

34th Bucium Street,
Iasi, Romania
+40 232 276 596
office@selftrust.ro

Sales office

96th Popa Stoica Farcas,
Bucharest, Romania
+40 213 32 405
office2@selftrust.ro

www.airportconveyors.eu

www.selftrust.ro
www.citconveyors.com



COLLECTING CONVEYORS



COLLECTING CONVEYORS



- The links between the Check-in conveyors and the Baggage Handling System (BHS) are the Collecting Conveyors.
- In certain layout configurations these conveyors are in plain site and it requires to be integrated in the terminal design and to have a less industrial design.
- Ergonomic with a low profile design, simple and robust;
- Fitted with low noise belt, antistatic and fire retardant;
- Stainless steel finish;
- Reliability and ease of maintenance.
- All the Conveyors can be customised in terms of design, dimensions and components thus having a Complete Custom Solution.



Quality components

Low gap between conveyors
eliminating the risk for the baggage to get stuck in transition

Easy access for maintenance procedures



CITCONveyors
Automated Conveyor Systems

division of

SELF TRUST
The Romanian Conveyor Factory

Airport industry

Head office and factory

34th Bucium Street,
Iasi, Romania
+40 232 276 596
office@selftrust.ro

Sales office

96th Popa Stoica Farcas,
Bucharest, Romania
+40 213 32 405
office2@selftrust.ro

www.airportconveyors.eu

www.selftrust.ro
www.citconveyors.com



BAGGAGE RECLAIM CAROUSEL HORIZONTAL



Friction
Drive

Caterpillar
Drive

BAGGAGE RECLAIM CAROUSEL



- Low noise;
- **Adjustable speed;**
- High capacity transport;
- **Available in different configurations: O, U, P, T shapes;**
- Strong structures;
- **Almost zero maintenance;**
- **Stainless steel finish;**
- **Fire retardant and friction-resistant slats;**
- Horizontal;
- **Length up to 100 linear meters;**
- Load up to 100 kilo per linear meter;
- **Active width 940 mm;**
- Height at slate level 400 mm.



Low noise



Low maintenance
required



High capacity
transport



CITCO conveyors
Automated Conveyor Systems

division of

SELF TRUST
The Romanian Conveyor Factory

Airport industry

Head office and factory

34th Bucium Street,
Iasi, Romania
+40 232 276 596
office@selftrust.ro

Sales office

96th Popa Stoica Farcas,
Bucharest, Romania
+40 213 32 405
office2@selftrust.ro

www.airportconveyors.eu

www.selftrust.ro
www.citconveyors.com

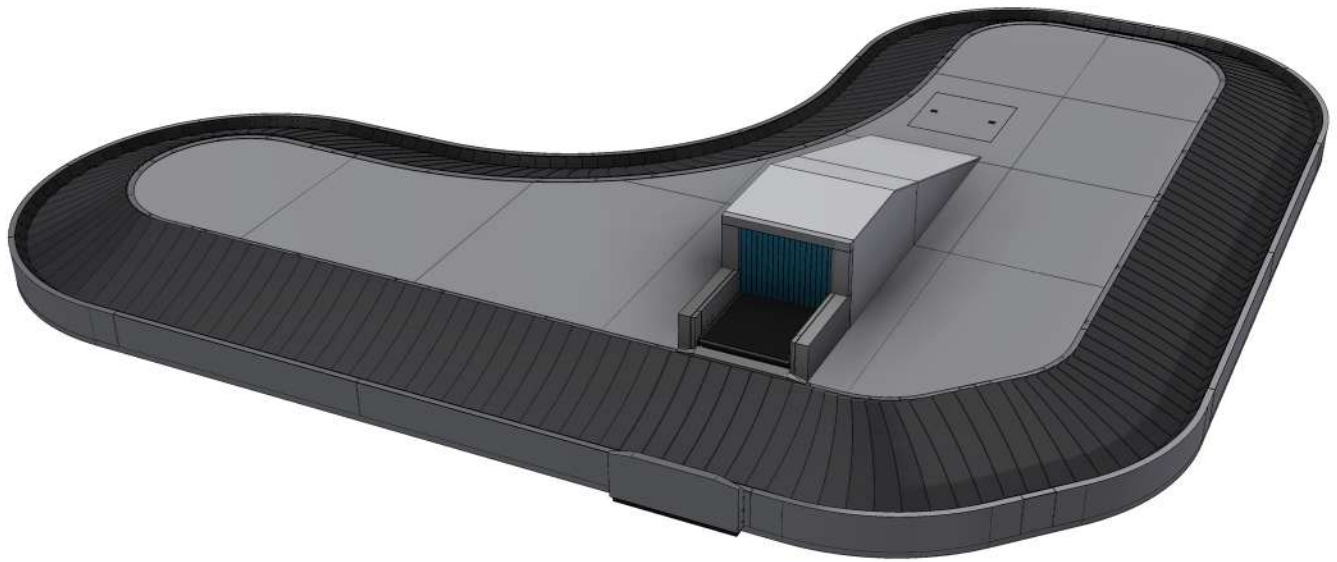

**BAGGAGE RECLAIM CAROUSEL
INCLINED**



BAGGAGE RECLAIM CAROUSEL



Type: Horizontal for U and Inclined for O Carousels;
Height at slot level 400 mm, with the possibility of adjustment ± 50 mm (Other heights can be produced if indicated);

Finishing: Stainless steel for the public area and powder coated mild steel for the loading area (the colour will be indicated by the client from the RAL Color Chart);

Engine used: SEW or equivalent (the power will be choosed according with the informations regarding the estimated weight per linear meter);

With a simple design and quality materials, the Baggage Reclaim Carousels produced by the **CITConveyors** factory are reliable, highly configurable, require virtually zero maintenance, and can be fitted to any airport project.



Designed for
easy use



Stand-Alone or
Integrated Control Panel



Designed for
easy maintenance



CITConveyors
Automated Conveyor Systems

division of

SELF TRUST
The Romanian Conveyor Factory

Airport industry

Head office and factory

34th Bucium Street,
Iasi, Romania
+40 232 276 596
office@selftrust.ro

Sales office

96th Popa Stoica Farcas,
Bucharest, Romania
+40 213 32 405
office2@selftrust.ro

www.airportconveyors.eu

www.selftrust.ro
www.citconveyors.com



BAGGAGE MAKE-UP CAROUSEL



BAGGAGE MAKE-UP CAROUSEL



- Low noise;
- Adjustable speed;
- High capacity transport;
- Available in different configurations;
- Strong structures;
- Almost zero maintenance;
- Stainless steel finish;
- Fire retardant and friction-resistant slats;
- Horizontal;
- Length up to 100 linear meters;
- Load up to 100 kilo per linear meter;
- Active width 940 mm;
- Height at slate level 400 mm.



Low noise



Low maintenance required



High capacity transport



CITCONveyors
Automated Conveyor Systems

division of

SELF TRUST
The Romanian Conveyor Factory

Airport industry

Head office and factory

34th Bucium Street,
Iasi, Romania
+40 232 276 596
office@selftrust.ro

Sales office

96th Popa Stoica Farcas,
Bucharest, Romania
+40 213 32 405
office2@selftrust.ro

www.airportconveyors.eu

www.selftrust.ro
www.citconveyors.com

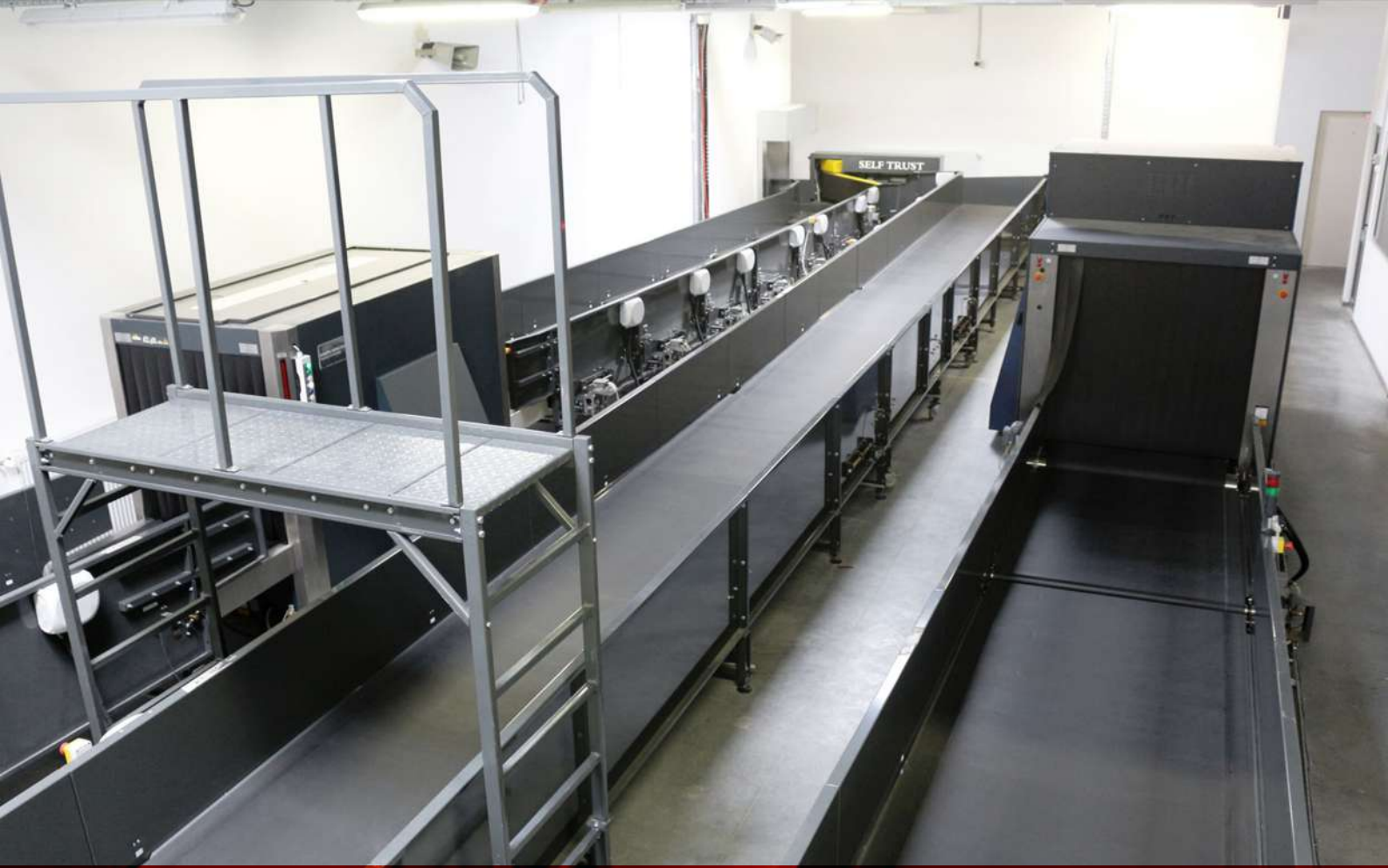

BAGGAGE HANDLING SYSTEMS



BAGGAGE HANDLING SYSTEMS



- Integrated control and automation;
- BHS designed taking into consideration redundancy and fail-safe options;
- Integration with a wide variety of scanning devices.
- Straight horizontal;
- Straight inclined;
- Powered curved (bend) at 30, 45 or 90 degrees;
- Horizontal and vertical diverters;
- Vertical Baggage Conveyors and Lifts;
- 30, 45 degrees angle injectors;
- Carousels;
- Gravity or powered roller conveyors.

For each BHS a dynamic simulation is made, from the design phase, to simulate capacity, critical points, optimal design solution and more.



Low noise

Available in a wide variety of layouts

High capacity transport



CITCONveyors
Automated Conveyor Systems

division of

SELF TRUST
The Romanian Conveyor Factory

Airport industry

Head office and factory

34th Bucium Street,
Iasi, Romania
+40 232 276 596
office@selftrust.ro

Sales office

96th Popa Stoica Farcas,
Bucharest, Romania
+40 213 32 405
office2@selftrust.ro

www.airportconveyors.eu

www.selftrust.ro
www.citconveyors.com



HORIZONTAL DIVERTERS

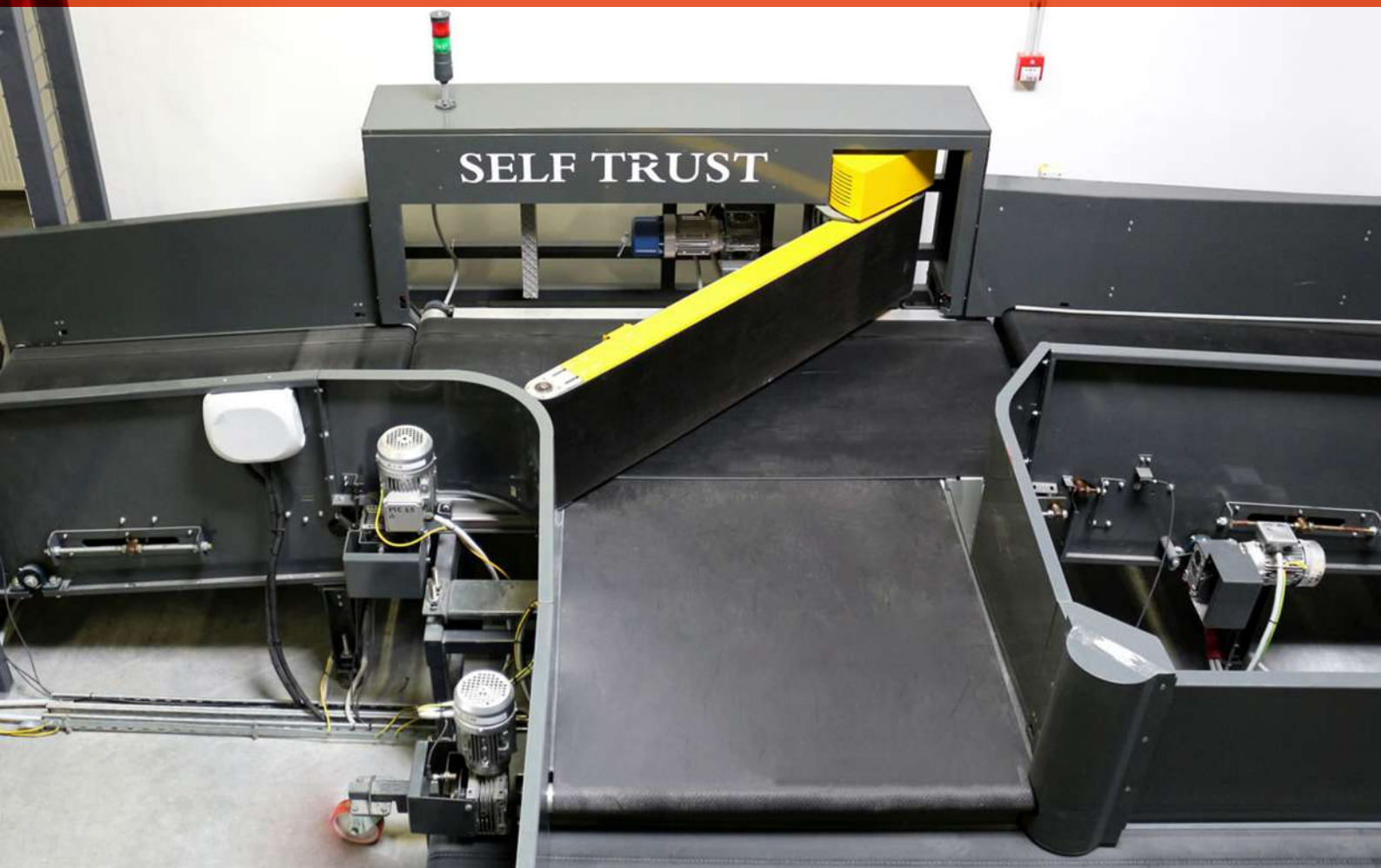

HORIZONTAL DIVERTERS



- Designed for 0% blockages
- Completely automated;
- Zero gap transfer;
- Available with 30°, 60° or 90° exit.
- High Troughoutput;
- Robust structure;
- Integration with a wide variety of scanning devices.

Baggage handling is a critical aspect of airport operations, and the efficient flow of luggage is essential for passenger satisfaction. A baggage diverter is a device used to separate baggage into different routes or destinations. There are two main types of baggage diverters - vertical and horizontal.

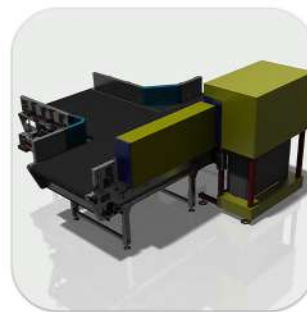
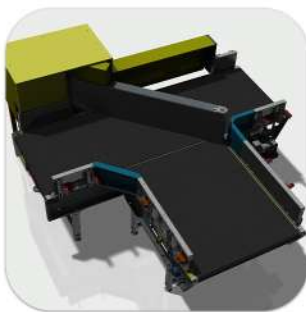

Low maintenance



Ajustable configuration according to existing layout



High capacity transport



CITCO conveyors
Automated Conveyor Systems

division of

SELF TRUST
The Romanian Conveyor Factory

Airport industry

Head office and factory

34th Bucium Street,
Iasi, Romania
+40 232 276 596
office@selftrust.ro

Sales office

96th Popa Stoica Farcas,
Bucharest, Romania
+40 213 32 405
office2@selftrust.ro

www.airportconveyors.eu

www.selftrust.ro
www.citcoconveyors.com



VERTICAL DIVERTERS

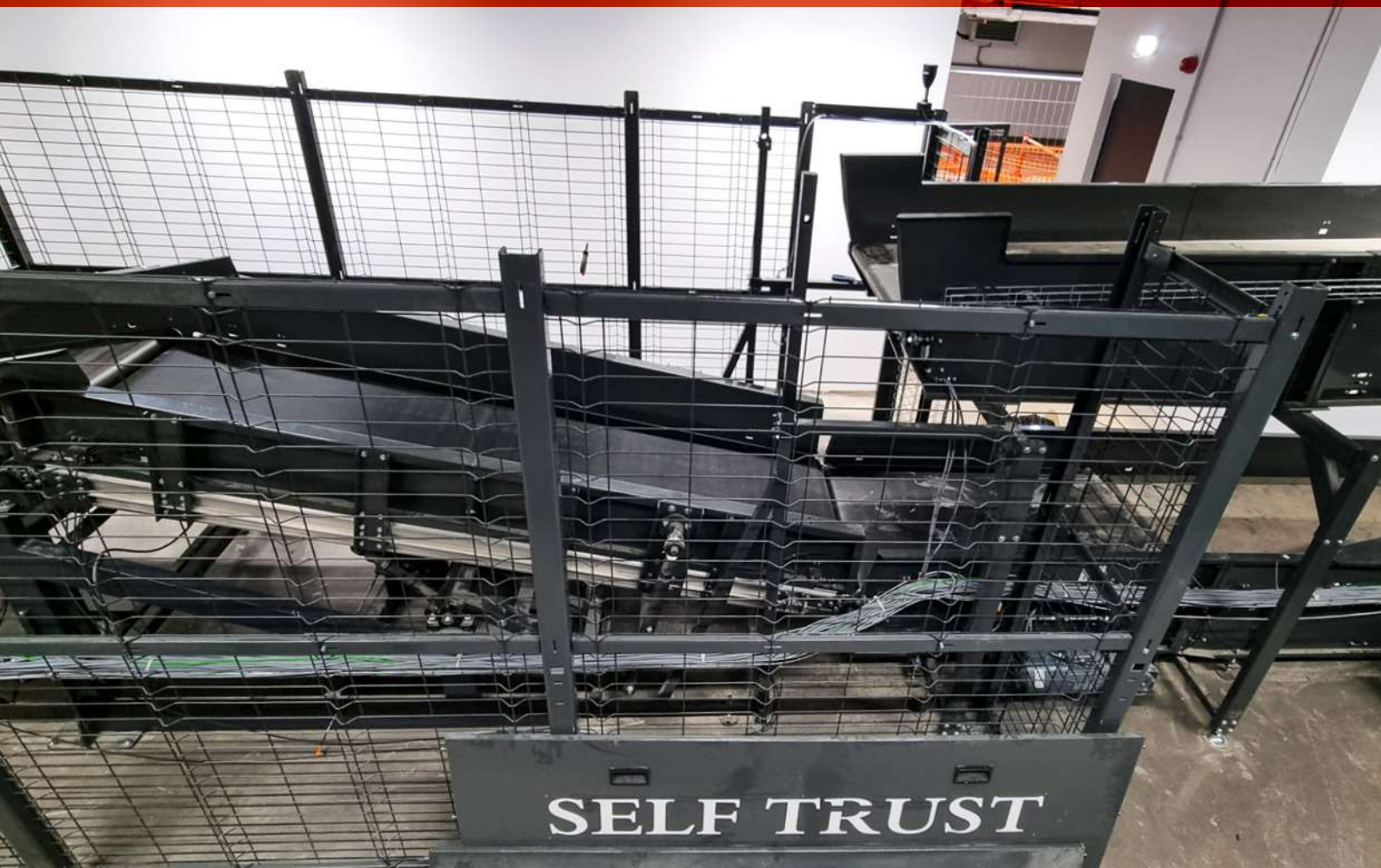

VERTICAL DIVERTERS



- Designed for 0% blockages
- Completely automated;
- Zero gap transfer;
- Available with 30°, 60° or 90° exit.
- High Troughoutput;
- Robust structure;
- Integration with a wide variety of scanning devices.

Vertical and Horizontal Baggage Diverters are essential components of airport baggage handling systems. The choice between the two depends on the specific needs of the airport, such as the size and type of bags, the destination of the bags, and the overall baggage handling system.



Low noise



Ajustable configuration
according to existing layout



High capacity
transport



CITCONveyors
Automated Conveyor Systems

division of

SELF TRUST
The Romanian Conveyor Factory

Airport industry

Head office and factory

34th Bucium Street,
Iasi, Romania
+40 232 276 596
office@selftrust.ro

Sales office

96th Popa Stoica Farcas,
Bucharest, Romania
+40 213 32 405
office2@selftrust.ro

www.airportconveyors.eu

www.selftrust.ro
www.citconveyors.com

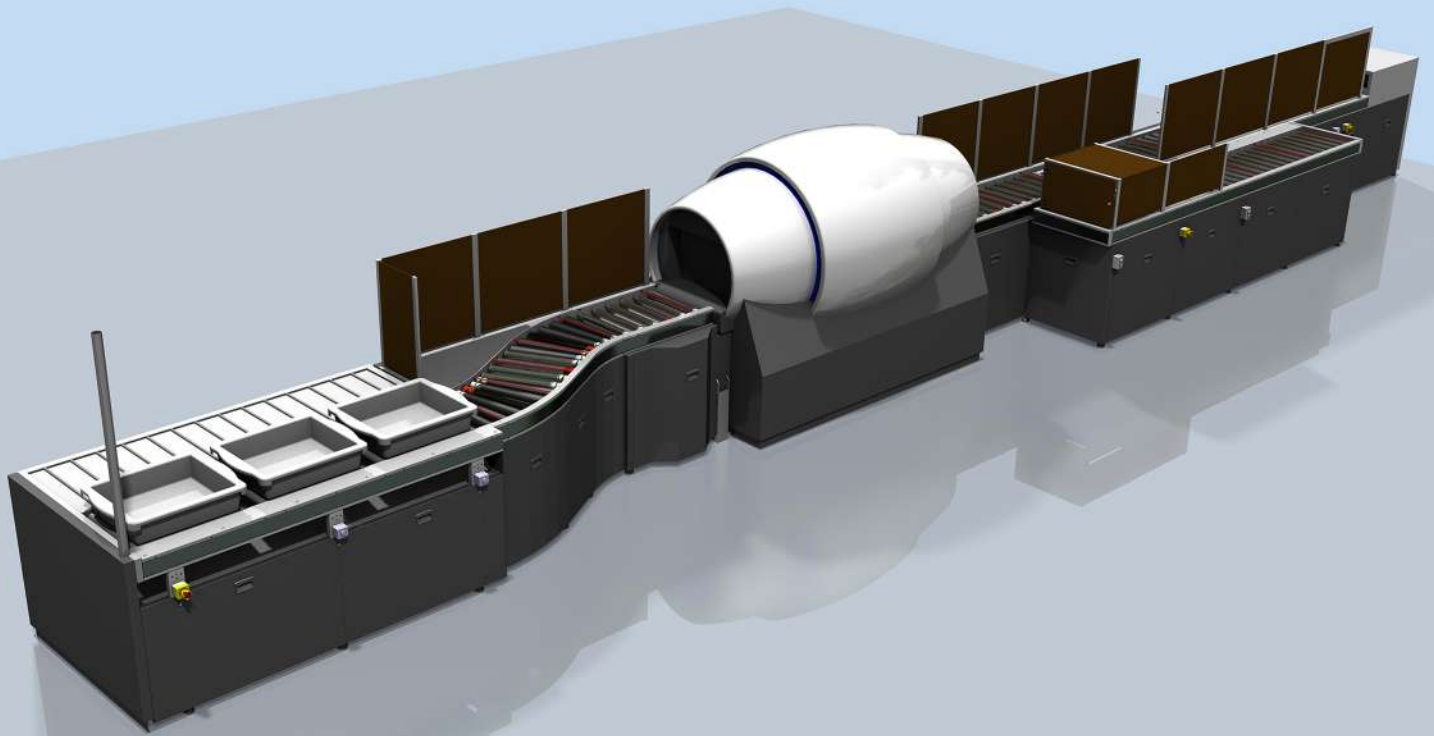

RETURN TRAY SYSTEM AUTOMATIC & MANUAL



RETURN TRAY SYSTEM

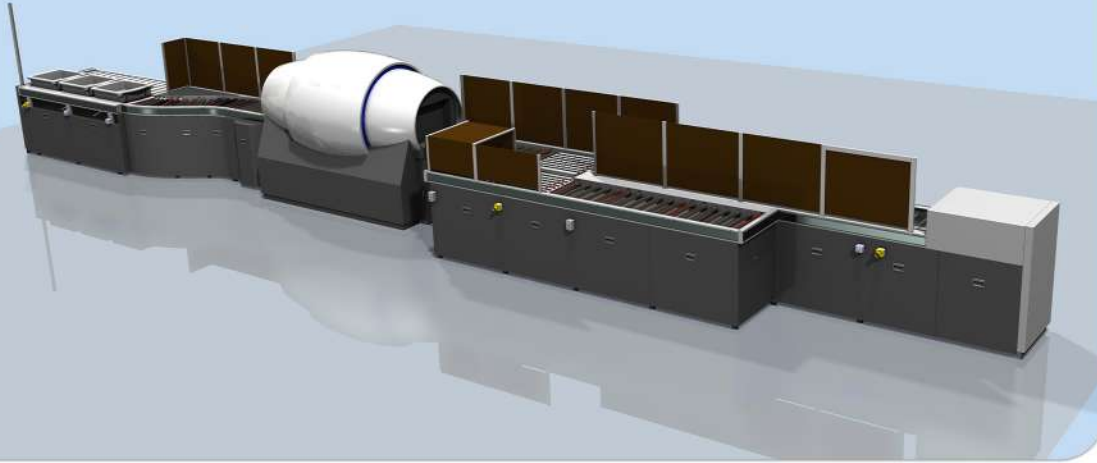

Innovative ATRS (Automatic Return Tray System) with high throughput and modular design:

- Suitable for airports with high passenger flow;
- Efficient and reliable management of carry-on luggage;
- Automatic tray return to the divest position;
- Modular and configurable design, adaptable to any checkpoint size;
- Optimization of throughput and operational efficiency.

Our Return Tray Systems have the following characteristics:

- Very easy usage for the passenger, no training required;
- Available in different length ;
- Allows accumulation;
- Step by step functioning (when a tote is picked up from the end of the RTS the other in the back are advancing until the end of the system).



High capacity transport



Available in a wide variety of lengths



Low power consumption



CITCONveyors
Automated Conveyor Systems

division of

SELF TRUST
The Romanian Conveyor Factory

Airport industry

Head office and factory

34th Bucium Street,
Iasi, Romania
+40 232 276 596
office@selftrust.ro

Sales office

96th Popa Stoica Farcas,
Bucharest, Romania
+40 213 32 405
office2@selftrust.ro

www.airportconveyors.eu

www.selftrust.ro
www.citconveyors.com



BELT CONVEYORS
BAGGAGE RUNWAY CONVEYORS



BELT CONVEYORS



- Solid construction (to allow high loads transport);
- Available with special belts to allow usage in low and high temperature;
- Available in powder painted finish or galvanized (for special requirements);
- Low noise;
- High capacity transport;
- Available in wide variety lengths and widths.



Limited maintenance required



Available in wide variety lengths and widths



Low noise



CITCONveyors
Automated Conveyor Systems

division of

SELF TRUST
The Romanian Conveyor Factory

Airport industry

Head office and factory

34th Bucium Street,
Iasi, Romania
+40 232 276 596
office@selftrust.ro

Sales office

96th Popa Stoica Farcas,
Bucharest, Romania
+40 213 32 405
office2@selftrust.ro

www.airportconveyors.eu

www.selftrust.ro
www.citconveyors.com



ROLLER CONVEYORS

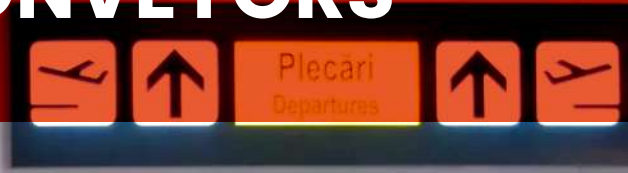

ROLLER CONVEYORS



- Solid construction;
- Available with PVC or Bright Zinc Rollers;
- Easy running rollers;
- Available with special rubber sleeve (to dampen the noise created by the impact of the baggage onto the rollers);
- Available in powder painted finish, stainless steel or galvanized (for special requirements).

Either we talk about the primary screening area for the passengers or we talk about the Baggage Handling System there are areas where Roller Conveyors are required for manual transfer of baggages or accumulation.



Low noise



Ajustable configuration according to existing layout



High capacity transport



CITCONveyors
Automated Conveyor Systems

division of

SELF TRUST
The Romanian Conveyor Factory

Airport industry

Head office and factory

34th Bucium Street,
Iasi, Romania
+40 232 276 596
office@selftrust.ro

Sales office

96th Popa Stoica Farcas,
Bucharest, Romania
+40 213 32 405
office2@selftrust.ro

www.airportconveyors.eu

www.selftrust.ro
www.citconveyors.com



MERGE UNITS – CONEXION
MDB – STRIP / CURVED – 30, 45, 60 DEGREES



MBD – 30, 45, 60 DEGREES

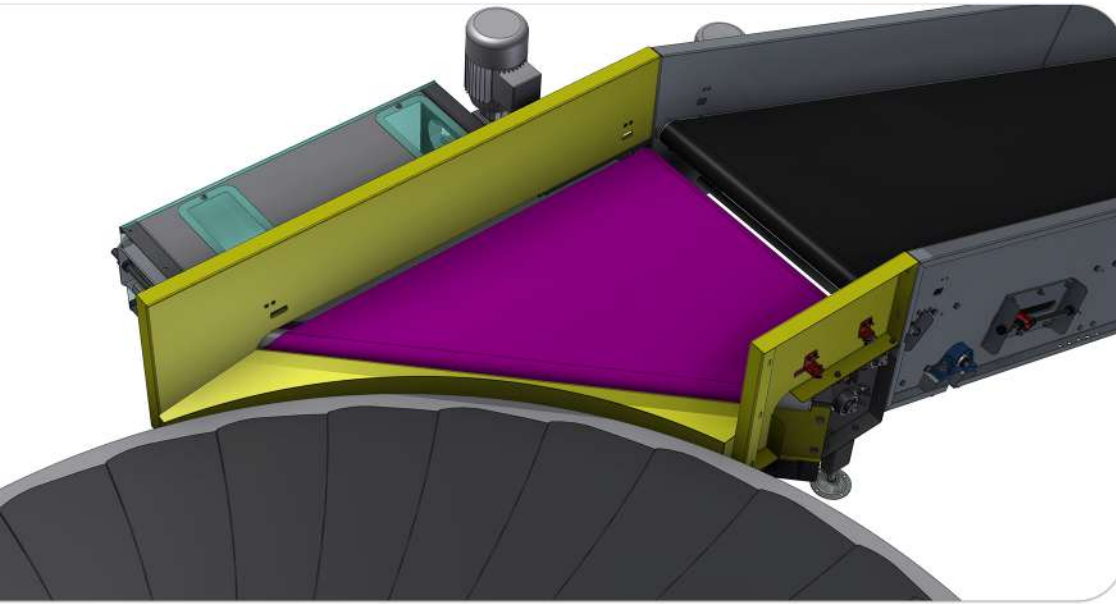

- 30 or 45 degrees in standard;
- Available also for straight connexion (MDB – straight – 30 or 45 degrees)*
- Nominal working speed 10m/min (other speeds available);
- Solid construction;
- Powder painted mild steel;
- Fitted with low noise belt, antistatic and fire retardant;
- Available with multiple types of accessories: sidewalls, sensors, emergency buttons;
- Tested reliability of the system;
- Low maintenance required.



CITCO conveyors
Automated Conveyor Systems

division of

SELF TRUST
The Romanian Conveyor Factory

Airport industry

Head office and factory

34th Bucium Street,
Iasi, Romania
+40 232 276 596
office@selftrust.ro

Sales office

96th Popa Stoica Farcas,
Bucharest, Romania
+40 213 32 405
office2@selftrust.ro

www.airportconveyors.eu

www.selftrust.ro
www.citconveyors.com



CURVED BELT CONVEYORS



CURVED BELT CONVEYORS



- Useful Width 1000 mm;
- 180 degrees;
- Inner radius 850 mm (other spokes available on request);
- Nominal working speed 10m/min (other speeds available);
- Electrostatically painted structure;
- Solid construction;
- Fitted with low noise belt, antistatic and fire retardant;
- Can be configured with CW or CWW operation;
- Available with multiple types of accessories: sidewalls, sensors, emergency buttons;
- Reliability and ease of maintenance.



Solid construction



CW or CWW operation



Easy to maintenance



CITCO conveyors
Automated Conveyor Systems

division of

SELF TRUST
The Romanian Conveyor Factory

Airport industry

Head office and factory

34th Bucium Street,
Iasi, Romania
+40 232 276 596
office@selftrust.ro

Sales office

96th Popa Stoica Farcas,
Bucharest, Romania
+40 213 32 405
office2@selftrust.ro

www.airportconveyors.eu

www.selftrust.ro
www.citconveyors.com



SPIRAL CHUTES



SPIRAL CHUTES



- Safe and fast downward movement;
- **Low procurement costs;**
- Fast and simple installation;
- **Custom infeed and exit chutes;**
- No moving parts and no spare and wear parts;
- **Durable construction with bolt-together;**
- Capable of handling different products at the same time;
- **Built for a smooth and even flow;**
- It can be customized to your application.



Low noise

Ajustable configuration
according to existing layout

High capacity
transport



CITCO conveyors
Automated Conveyor Systems

division of

SELF TRUST
The Romanian Conveyor Factory

Airport industry

Head office and factory

34th Bucium Street,
Iasi, Romania
+40 232 276 596
office@selftrust.ro

Sales office

96th Popa Stoica Farcas,
Bucharest, Romania
+40 213 32 405
office2@selftrust.ro

www.airportconveyors.eu

www.selftrust.ro
www.citconveyors.com



SELF CHECK-IN KIOSKS



SELF CHECK-IN KIOSKS



The Self Check-In systems offered by CITCONveyors is a fast, contactless, self-service system for printing the label attached to the luggage. This system is very fast, with the label available in less than 8 seconds.

With a quick, easy and contactless operation, the Self Check-in system reduces the time passengers spend boarding. Compared to traditional kiosks, the system has a much lower price and greater mobility.

Benefits:

- Fast (8 seconds);
- Intuitive;
- Mobile (battery powered option);
- Simple and intuitive interface;
- Contactless.



Scan the ticket



The tag is printed



Ready to attach to the luggage



CITCONveyors
Automated Conveyor Systems

division of

SELF TRUST
The Romanian Conveyor Factory

Airport industry

Head office and factory

34th Bucium Street,
Iasi, Romania
+40 232 276 596
office@selftrust.ro

Sales office

96th Popa Stoica Farcas,
Bucharest, Romania
+40 213 32 405
office2@selftrust.ro

www.airportconveyors.eu

www.selftrust.ro
www.citconveyors.com



BAGGAGE DROP SYSTEMS (SBD)



BAGGAGE DROP SYSTEMS (SBD)



The Baggage Drop Systems offered by SELF TRUST is a fast self-service system for luggage. This system reduces the time spent by passengers in handing over their luggage, giving them a better start to their journey. Passengers benefit from less time spent in line and less stress.

Intuitive and fast, the Baggage Drop System doubles the luggage handling capacity. It can be fully integrated with existing conveyors and weighing cells, but also with existing furniture.

Benefits:

- Fast (11 seconds);
- Dual use (automatic and manual);
- High utilization rate >90%;
- Simple and intuitive for passengers;
- Modular design;
- Easy installation.



Handheld scanner



Contactless



Side mounting,



CITCONveyors
Automated Conveyor Systems

division of

SELF TRUST
The Romanian Conveyor Factory

Airport industry

Head office and factory

34th Bucium Street,
Iasi, Romania
+40 232 276 596
office@selftrust.ro

Sales office

96th Popa Stoica Farcas,
Bucharest, Romania
+40 213 32 405
office2@selftrust.ro

www.airportconveyors.eu

www.selftrust.ro
www.citconveyors.com



PASSPORT CONTROL CABINS



PASSPORT CONTROL CABINS



- Visible structure made from stainless steel profiles.
- The bottom of the cabin is made from wood material covered with special high traffic plastic material, gray color and it will cover also the electrical wirings
- For access in the cabin, a door is fitted. Made from wood and with duplex secured glass on top, 8 mm thickness.
- The lateral window is made from duplex secured glass, sandblasted with horizontal stripes.
- The front side of the wall is covered with stainless steel, with Corian and composite material.
- The cabin is fitted with a front shelf.
- The inside furniture is made from gray wood and the countertop is fitted with composite material (CORIAN).

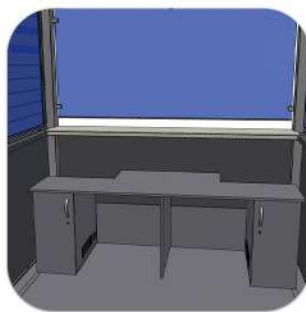

Durable construction



Custom manufactured



Made from quality materials



CITCONveyors
Automated Conveyor Systems

division of

SELF TRUST
The Romanian Conveyor Factory

Airport industry

Head office and factory

34th Bucium Street,
Iasi, Romania
+40 232 276 596
office@selftrust.ro

Sales office

96th Popa Stoica Farcas,
Bucharest, Romania
+40 213 32 405
office2@selftrust.ro

www.airportconveyors.eu

www.selftrust.ro
www.citconveyors.com



Our mission is to professionally and efficiently meet customer requirements by delivering high-quality, tailored solutions. Each product or system is designed and built inside our company, ensuring full control over quality and innovation.

From the manufacturing of conveyors and specialized equipment to the seamless integration and automation of baggage handling systems, we are your reliable partner in airport and logistics operations. We develop solutions that optimize processes, enhance passenger flow, and meet the demanding requirements of modern airports, focusing on efficiency, reliability, and scalability.



Romania



+40 232 276 596
+40 728 441 821



info@citconveyors.com
office@selftrust.ro

Global Expertise in Airport Conveyor Solutions

www.airportconveyors.eu